

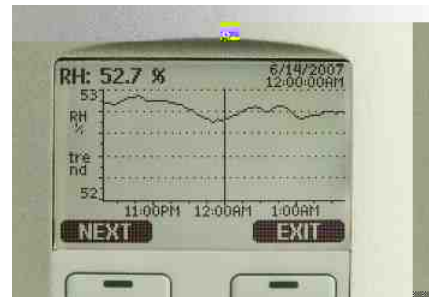



HMT330



HMT330

- HMT331
- HMT333
- HMT334
- HMT335
- HMT337
- HMT338

Microsoft Windows®

PC
(WLAN

USB

HMT330

PC

HMT330

() HMT300

USB

viewLink

“ 11

RS232 RS485/422

HMT330

/ 11”

HMT330

MODBUS

MODBUS

RTU (RS485) MODBUS TCP/IP ()

HMT0

HMT15

(ISO/IEC17025)



RH
 ()
 HLMICAP® 180 180R*
 HLMICAP® 180C 180RC* /
 HLMICAP®180VC
 H₂O
 +15...+25°C (59...+77°F) ± 1 %RH (0...90 %)
 ± 1.7 %RH (90...100 %RH)
 -20...+40°C (-4...+104°F) ± (1.0 + 0.008x) %RH
 -40...+180°C (-40...+356°F) ± (1.5 + 0.015x) %RH
 (+20°C) ± 0.6 %RH (0...40 %RH)
 ± 1.0 %RH (40...97 %RH)
 *(± 2)
 +20°C (+68°F) (90%) 8 /
 17 **
 + 20 /50 **
 40 /60 **
 * HLMICAP 180R 180RC*
 ** HLMICAP 180R 180RC 180VC
 +20°C (+68°F) ± 0.2°C (± 0.36°F)

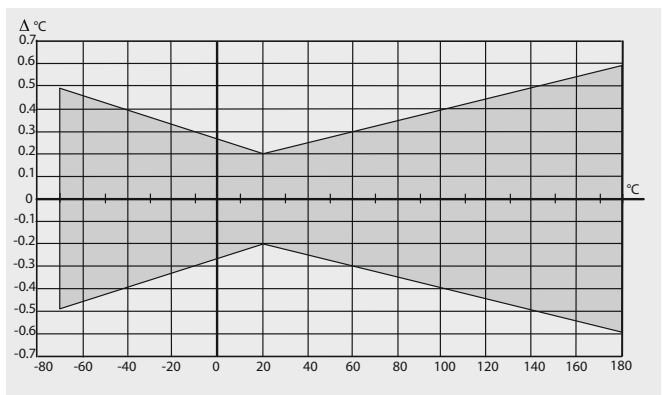

Pt 100 RID FQ 1 IEC 60751

10...35 VDC, 24 VAC ± 20%
 100...240 VAC, 50/60 HZ
 +20°C (U_{in} 24 VDC)
 RS232 25 mA
 U_{out} 2 x 0...1 V/0...5 V/...10 V 25 mA
 I_{out} 2 x 0...20 mA 60 mA
 + 20 mA
 110 mA
 + 120 mA
 (HMT337)
 2 , 3)
 0...20 mA 4...20 mA
 0...1 V, 0...5 V, 0...10 V
 ± 0.05%
 ± 0.005%/°C
 R_L < 500 ohm
 R_L > 2 kohm
 R_L > 10 kohm
 0.5 mm² (AWG 20)
 RS232, RS485 ()
 ASCII MODBUS RTU
 RS232, USB
 0.5 A 250 VAC
 10BASE-T, 100BASE-TX
 8P8C (RJ45)
 DHC ()
 Tel net, MODBUS TCP/IP
 802.11b
 RP-SMA
 DHC ()
 Tel net, MODBUS TCP/IP
 VEP 64/128, VPA2/802.11i
 IPv4
 WAN ()
 IPv4
 / (WAN)
 /
 /VEP
 VPA /TKIP
 VPA /CCMP VPA2)
 / /
 10)
 4 5
 1370
 5
 LCD





M20 x 1.5
8...11 mm / 0.31...0.43"
1/2" NPT
M2 8
1 , 5 16.4
2 ,
HM333 (+80°C) 6.0 mm
5.5 mm
2 5 10
)
G Al Si 10 Mg (DIN 1725)
IP 66
IP65 (NEMA 4X),
1.0 - 3.0 kgs

VLAN

-40...+60°C (-40...140°F)
0...+60°C (32...140°F)
EMC
EN61326-1,
IEC61000-4-5 40



HMT331



HMT331

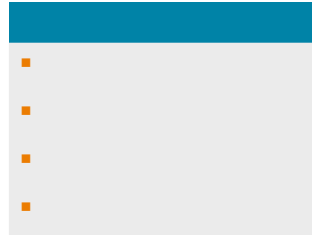

VLAN HMT331

HMICAP®

HMT331

-40...+60 °C (-40...+140 °F)

	PC	USB	219916
HMT0			211339
			214829
			215109
DI N			215094
		PPS	DRV010281SP
			HM7280SP

HMT333

HMICAP®
HMT333



HMT333

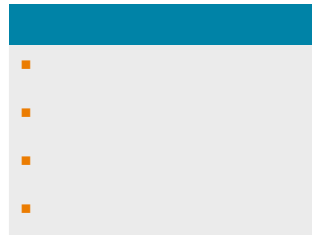

HMT333 HMT337

HMT333

—

+80 °C

+120 °C

(+80 °C)

20

2 5 10

DTR502B

-40...+80 °C (-40...+176 °F)

-40...+120 °C (-40...+248 °F)

			210697
			HMP247CG
HMT0	PC	USB	219916
			211339
			214829
DI N			215109
			DTR502B
PPS			215094
		PPS	DRV010281SP
			DRV010276SP
			HM7280SP

HMT334



HMT334

HMICAP®

HMT334

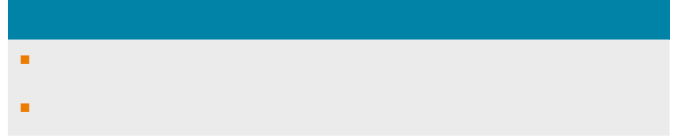

-70...+180 °C (-94...+356 °F)
0...10 MPa (0...100 bar)

	ISO M22 x 1.5	17223SP
	NPT 1/2"	17225SP
PC	USB	219916
H70		211339
		214829
		215109
DIN		215094
	PPS	DRW010281SP
PPS		DRW010276SP
		HM47280SP
		HM47453SP

HMT335



HMT335

HMICAP®

HMT335



-70...+180 °C (-94...+356 °F)

		210696
PC	USB	219916
H70		211339
		214829
		215109
DIN		215094
	PPS	DRW010281SP
PPS		DRW010276SP
		HM47280SP
		HM47453SP

HMT335

HMT337



HMT337

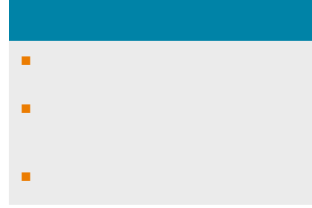

HMT333 HMT337

HMICAP®

HMT337

-
-
-

		- 70...+180 °C (- 94...+356 ° F)	
		*	
	AGRO		HMP247CG 210697 215003
		Swagel ok (NPT ISO (10)	DIR502B HMT330MIK
	PC USB		219916 211339 214829 215109
	H70		215094
	DI N		HMT330MPA
		PPS	DRV010281SP DRV010276SP HM728OSP HM7453SP
	PPS		
		*	

Swagel ok®
HMT330MIK

HMT338



HMT338

HMCAP®

HMT338

10 Bar



-70...+180 °C (-94...+356 °F)

0...4MPa (0...40 bar)

			BALLVALVE-1
			210662
	ISO 1/2	NPT 1/2	219916
	PC	USB	211339
H70			214829
			215109
DI N			215094
		PPS	DRV010281SP
PPS			DRV010276SP
			HM7280SP
			HM7453SP

HMT330

HMT331

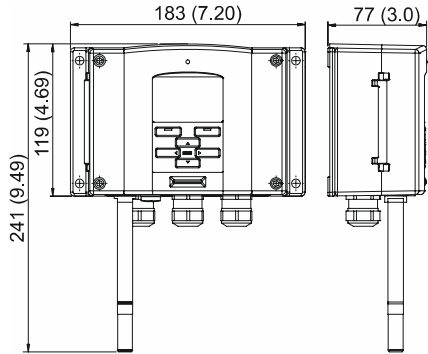

HMT335

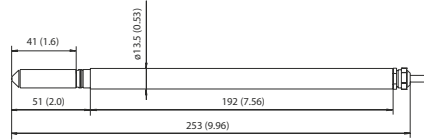

HMT338

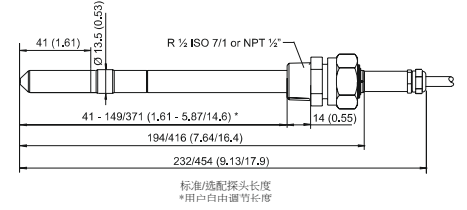

HMT333

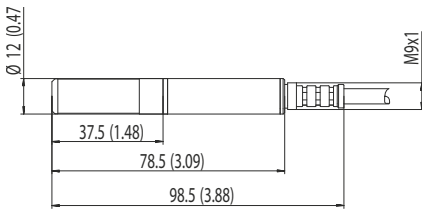

HMT337

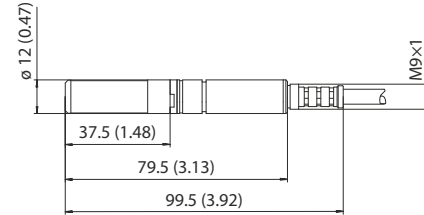

HMT334

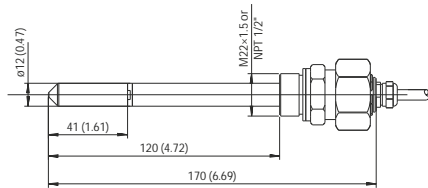

HMT337

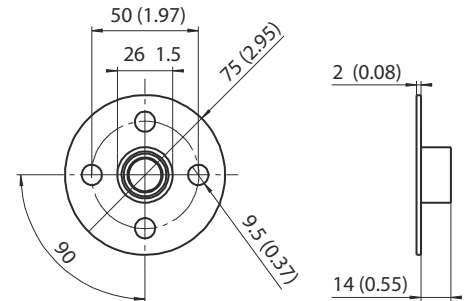
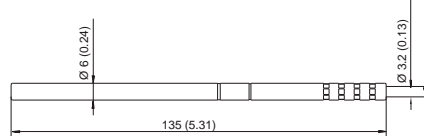

详情请访问：www.system-instruments.com

电话：0756-2127068

授权代理商：珠海赛思特仪表设备有限公司